

SERIAL NUMBER: Q/KR.C09-05-186

JIANGMEN KREALUX ELECTRICAL APPLIANCES CO., LTD				MODEL NO: P02-D2			
DRAWN		DATE		EDITION	A	SCALE	2:1

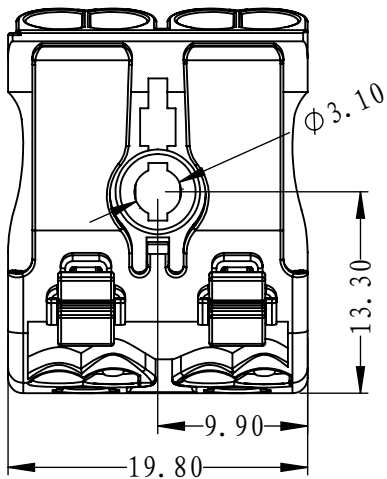
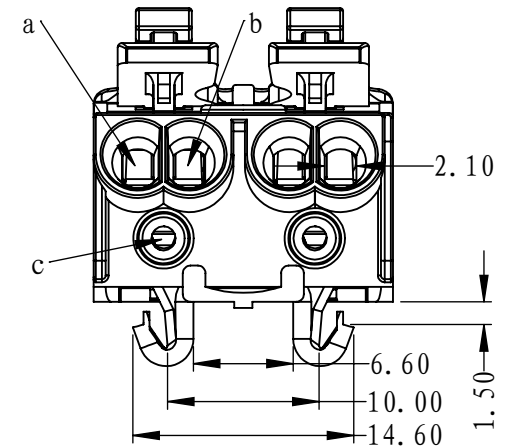
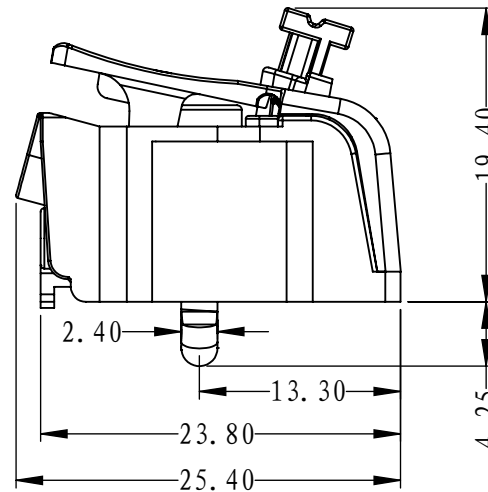
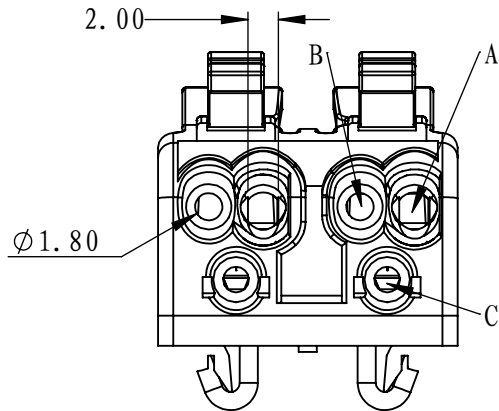
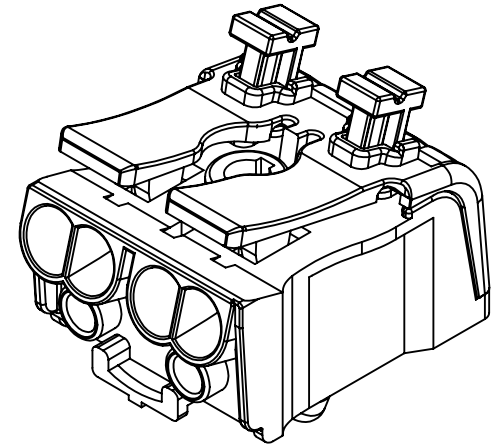
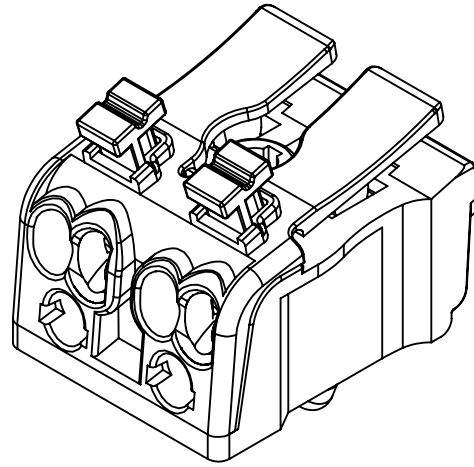
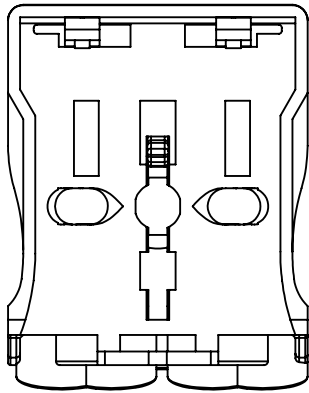

SERIAL NUMBER: Q/KR.C09-05-186

JIANGMEN KREALUX ELECTRICAL APPLIANCES CO., LTD				MODEL NO: P02-D2J			
DRAWN		DATE		EDITION	A	SCALE	2:1